

NADY™
AUDIO

OWNER'S MANUAL



SRM SERIES MIXING CONSOLE

SRM-12X – 12 Channel Stereo Mic/Line Mixer

SRM-14X – 14 Channel Stereo Mic/Line Mixer

SRM SERIES STEREO MIC/LINE MIXERS

SRM-12X & SRM-14X



Congratulations on your choice of mixers — you have purchased one of the finest compact mixing consoles on the market today. This unit was developed using the expertise of professional sound engineers and working musicians. You will find that your new NADY AUDIO mixer has superior performance and greater flexibility than any other mixer in its price range. Please read this manual carefully to get the most out of your new unit.

Thanks for selecting NADY AUDIO as your choice in mixing consoles.

Date of Purchase _____

Dealer's Name _____

City _____

State _____

Zip _____

Model # _____

Serial # _____

CONTENTS

WARNING	3
FEATURES	4
INSTALLATION	5
1. Inspection	5
2. Rackmounting	5
3. Power Connection.....	5
CONTROLS AND CONNECTIONS	6
1. Mono Input Section	6
2. Stereo Input Section.....	8
3. Master Section	9
a. Aux Sends>Returns Function and Operation	9
b. Main Mix Function and Operation	9
c. Monitor Function and Operation	10
d. Power Switches	10
4. Connections.....	11
SPECIFICATIONS	12
BLOCK DIAGRAM	13
NOTES	14

WARNING



An equilateral triangle enclosing a lightning flash/arrowhead symbol is intended to alert the user to the presence of uninsulated "dangerous voltage" within the product's enclosure which may be of sufficient magnitude to constitute a risk of electric shock.



An equilateral triangle enclosing an exclamation point is intended to alert the user to the presence of important operating and service instructions in the literature enclosed with this unit.

IMPORTANT SAFETY INSTRUCTIONS

When using this electronic device, basic precautions should always be taken, including the following:

1. Read all instructions before using the product.
2. Do not use this product near water (e.g., near a bathtub, washbowl, kitchen sink, in a wet basement, or near a swimming pool, etc.).
3. This product should be used only with a cart or stand that will keep it level and stable and prevent wobbling.
4. This product, in combination with headphones or speakers, may be capable of producing sound levels that could cause permanent hearing loss. Do not operate for a long period of time at a high volume level or at a level that is uncomfortable. If you experience any hearing loss or ringing in the ears, you should consult an audiologist.
5. The product should be positioned so that proper ventilation is maintained.
6. The product should be located away from heat sources such as radiators, heat vents, or other devices (including amplifiers) that produce heat.
7. The product should be connected to a power supply only of the type described in the operating instructions or as marked on the product. Replace the fuse only with one of the specified type, size, and correct rating.
8. The power supply cord should: (1) be undamaged, (2) never share an outlet or extension cord with other devices so that the outlet's or extension cord's power rating is exceeded, and (3) never be left plugged into the outlet when not being used for a long period of time.
9. Care should be taken so that objects do not fall into, and liquids are not spilled through, the enclosure's openings.
10. The product should be serviced by qualified service personnel if:
 - A. The power supply cord or the plug has been damaged.
 - B. Objects have fallen into, or liquid has been spilled onto the product.
 - C. The product has been exposed to rain.
 - D. The product does not appear to operate normally or exhibits a marked change in performance.
 - E. The product has been dropped, or the enclosure damaged.
11. Do not attempt to service the product beyond what is described in the user maintenance instructions. All other servicing should be referred to qualified service personnel.

FEATURES

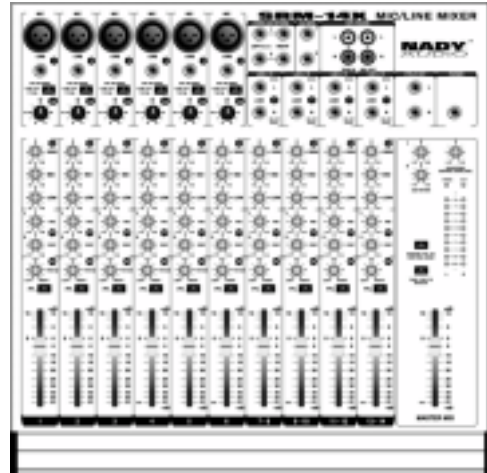
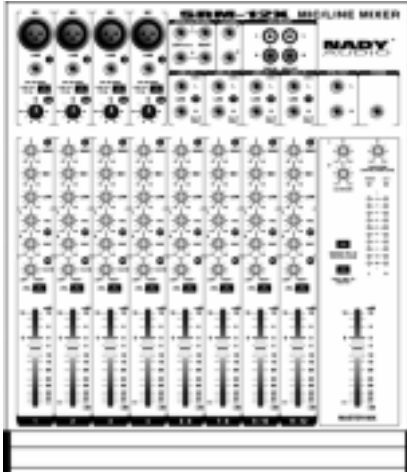

SRM SERIES STEREO MIC/LINE MIXERS

The SRM-12X and SRM-14X are the ultimate value in compact professional stereo mic/line mixers. Rackmounted (with supplied rack ears) or as compact desk consoles, these high quality units are perfect for home and project studios, live club main and monitor mixing, video post-production studios, remote broadcasting — in fact, anywhere superior performance, rugged reliability and ultra-versatility are needed in an audio mixer. The operating instructions in this manual are for the SRM-12X and SRM-14X stereo rack mixers. For brevity, in most of this manual the copy refers to the SRM-14X (as this model has the most inputs) but the instructions apply to the operation of the SRM-12X as well. With 12 and 14 channels respectively, as well as 2 stereo AUX returns, and 2 tape inputs, the SRM-12X offers 16 and the SRM-14X 18 total inputs in all. Common features include:

- Ultra-low-noise mic preamps
- Wide dynamic range with superior headroom
- Separate Master Mix, Control Room and Headphone Outputs
- 3-band EQ on all channels
- Mic and Line Balanced inputs for optimum audio integrity
- Tape In and Record Out RCA jacks with Tape inputs assignable to Master Mix or stereo Control Room/Headphone outputs
- Switchable global +48V phantom power on all mono inputs
- Input Trim control on each mono channel
- Pan pots on each mono channel and Balance pots on each stereo input
- Pre and post-fader Aux Sends for external effects and monitoring
- 2 multifunction stereo Aux Returns with Aux Return controls
- Switchable Low Cut filters (18 dB/octave @ 75 Hz) on mono channels
- PFL (Pre-Fader Listen) function on all channels
- 60 mm faders on all channels and Master Mix for precise level control
- 1/4" TRS and XLR Stereo Outputs
- Peak LEDs on input channels
- Dual 10-segment LED display bargraph meters
- High quality sealed pots with center detents
- High-strength steel casing and superior construction with only highest quality components for longest life and maximum reliability
- External AC supply for optimum signal integrity and superior transient response

Separate features include:

SRM-12X

- 12 Channel Stereo Mic/Line Mixer
- 4 mono input channels with balanced XLR Mic and 1/4" TRS line inputs
- 8 stereo input channels with balanced 1/4" TRS jacks for balanced or unbalanced inputs
- Four 1/4" TRS inserts allow independent connection of effects devices for each mono channel
- Dimensions & Weight: 13.5" x 11.5" x 3" (343 x 292 x 76 mm), 7.9 lbs (3.6 Kg)

SRM-14X

- 14 Channel Stereo Mic/Line Mixer
- 6 mono input channels with balanced XLR Mic and 1/4" TRS line inputs
- 8 stereo input channels with balanced 1/4" TRS jacks for balanced or unbalanced inputs
- Six 1/4" TRS inserts allow independent connection of effects devices for each mono channel
- Dimensions & Weight: 13.5" x 13.5" x 3" (343 x 343 x 76 mm), 9.3 lbs (4.2 Kg)

INSTALLATION

To ensure years of enjoyment from your **NADY AUDIO SRM Series** mixing console, please read and understand this manual thoroughly before using the unit.

1. INSPECTION

Your NADY AUDIO SRM-12X/14X was carefully packed at the factory in packaging designed to protect the units in shipment. Before installing and using your unit, carefully examine the packaging and all contents for any signs of physical damage that may have occurred in transit.

[Please note: Nady Systems is not responsible for shipping damage. If your unit is damaged, do not return to Nady, but notify your dealer and the shipping company (if shipped to you) immediately to make a claim. Such claims must be made by the consignee in a timely manner.]

2. RACK MOUNTING

Enclosed in the shipping box you will find a rackmount kit. If you want to make your SRM-12X/14X a rack mixer, remove the screws from the side panels and use them to fix the rack ears (note that there is a left and a right one).

Parts of the mixer and the power supply unit can become very warm during use. This is normal during operation. Care should be taken to ensure that there is enough space around the unit for cooling. Also, do not place the SRM-12X/14X on high temperature devices such as power amplifiers etc. or the unit may overheat in operation.

Although the unit's chassis is shielded against radio frequency (RF) and electromagnetic interference (EMI), extremely high fields of RF and EMI should be avoided.

3. POWER CONNECTION

The SRM-12X/14X is designed to operate with the supplied external power supply unit (PSU). Please make sure that the power unit supplied is marked for the correct voltage in your area (120VAC/60 Hz or 230VAC/50Hz). Power requirements for electrical equipment differ from area to area. In new installations and portable sound systems, or any situation in which the AC power is in question, it is wise to confirm the voltage and use the appropriate power supply unit before connecting it to power sources.

Check to see that the unit is set to the voltage for your area by referring to the table below:

Europe (except UK): 230V, 50Hz
UK and Australia: 240V, 50Hz
USA and Canada: 120V, 60 Hz

For other areas, please check with local authorities.

Do not connect the PSU to the SRM-12X/14X while the PSU is connected to the AC mains supply. Connect the switched-off SRM-12X/14X and PSU first before you connect the PSU to the mains supply. Lastly switch on the SRM-12X/14X with the power switch on the back panel. Use only the correct NADY power supply unit to connect the SRM-12X/14X to the Mains AC power.

CONTROLS AND CONNECTIONS

1. MONO INPUT SECTION

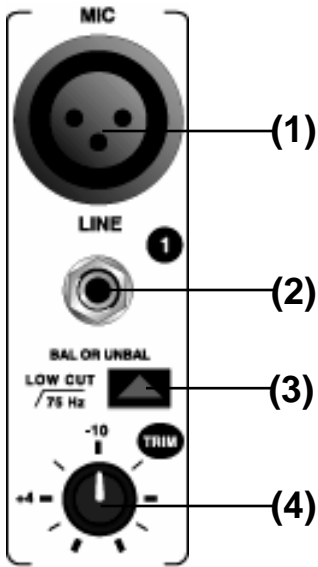

(1) MIC INPUT

The Mic input is an electronically balanced XLR type designed to accept signals from any balanced low impedance (Low Z) microphone. To accommodate condenser microphones, this input is also equipped with +48VDC phantom power globally switchable to all XLR input jacks with the **Phantom Power switch (25)** on the back panel. Dynamic or ribbon-type microphones do not require phantom powering. It will be necessary to adjust the channel gain with the input **Trim control (4)** to

achieve a nominal operating level. The XLR jack is configured for: Pin1 = ground, Pin2 = positive (+), Pin3 = negative (-).

[Note: The Mic inputs are more sensitive than the Line inputs. Also, do not connect mics with the phantom power switched on, as indicated by the **Phantom Power On LED (26)** in the Master Section of the front panel. Never use unbalanced mic cables with the Phantom Power switched on. Never short the +48VDC to ground, as that can cause serious damage to your mixer. Also, mute the Monitor/PA speakers when turning the phantom power on or off.]

(2) LINE INPUT

The Line input is designed to accept balanced or unbalanced line-level signals such as those from keyboards, drum machines, or samplers. There is enough gain available on the line input to accept even lower level signals, such as those from an unbalanced microphone or guitar output. Use the **Trim control (4)** to adjust for the desired level. If a balanced signal is to be connected to the line input, then a 1/4" TRS (stereo) phone plug should be wired for: Tip = positive (+), Ring = negative (-), Sleeve = ground.

(Note: Only either the Mic or the Line input of a given channel can be connected at one time. Never connect both simultaneously to the same channel.)

(29) INSERTS

Channels 1-4 (SRM-12X) and 1-6 (SRM-14X) are equipped with rear panel insert jacks to connect external signal processors, such as compressors, noise reduction systems, or effects devices, to the individual input channels. Insert points are useful for adding dynamic processing or equalization to a channel or the mix. Unlike reverbs etc., which are usually added to the dry signal, dynamic processing is normally applied across an entire signal. Here an Aux Send would be inappropriate. Instead the signal is intercepted somewhere along the channel, fed through the dynamics processor and/or EQ, then returned to the console at the same point where it left. The insert point is normalized, i.e. the signal is only interrupted when a jack is plugged into it. The insert jack is located pre EQ in the channel and is configured as: Tip = send, Ring = return, Sleeve = ground.

The Insert can also be used as a channel direct output by sending the signal from the ring. To use the Insert as a direct output, insert a 1/4" phone plug halfway into the Insert jack so the tip of the plug connects with the ring of the insert jack. The jack will click into place when the connection to the ring is made.

(4) TRIM CONTROL

The trim control adjusts the input sensitivity (channel gain) of the mic and line inputs on the mono input channels. This control can be adjusted to accommodate input signals from a wide variety of sources, from the high outputs from keyboards or drum machines to the small signal outputs of microphones. This wide range eliminates the need for Mic/Line switching. The best balance of S/N and dynamic range will be achieved if you adjust the TRIM control on each channel separately so that the **Peak Indicator LED (8)** for that channel lights occasionally.

(3) LOW CUT FILTER

Use this Low-Cut (high-pass) filter (18 dB/octave, -3 dB at 75 Hz) for reducing floor rumble, popping, breathing noises, woolly bottom end, and to tighten up channels in a mix, etc. It is most effective when used carefully in conjunction with the **Equalizer Controls (5)**.

(5) EQUALIZER CONTROLS

All mono input channels are fitted with a three-band EQ. All three bands have up to 15 dB of cut and boost, with a center detent for "off". The frequency response is flat when all three EQ knobs are in the center detent position. The upper and lower shelving controls have their frequencies fixed at 12 kHz and 80 Hz respectively. The midrange control has a peaking response at 2.5KHz (Q fixed at 1 octave). Remember that the

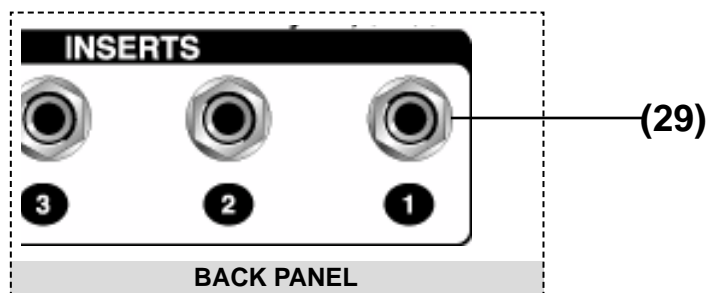

CONTROLS AND CONNECTIONS

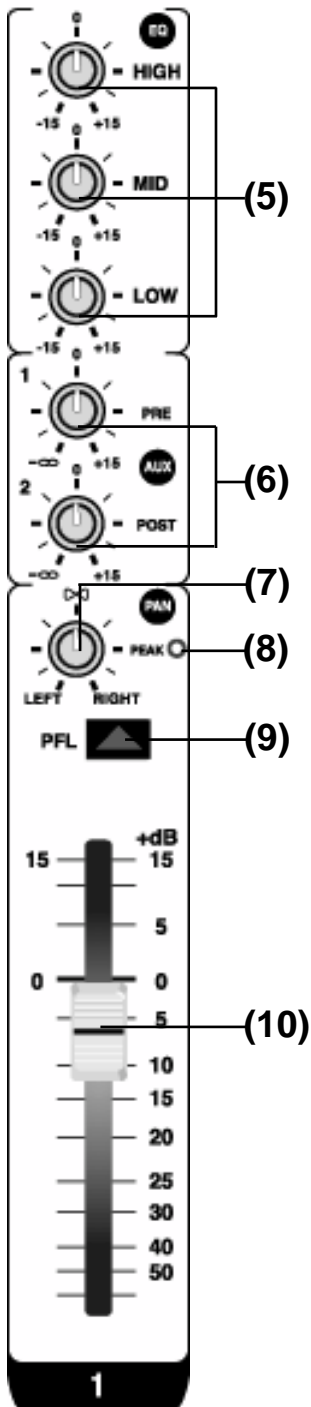

Low Cut filter (3) is an integral part of the overall equalization of a mono channel. The channel EQ is a valuable feature of the mixer as it allows the user to control the tonal characteristics of each instrument separately. For example, boosting the LOW can fatten the sound and add punch to the bass or drums; the MID control can be used to define the midrange or bring out the vocals; and adjusting the HIGH control can provide a crisp sounding high end. With the LOW set to boost, and the Low Cut switch activated, you get peak response rather than shelving at the bottom end. This is useful for adding warmth to vocals and instruments, and good for tight but deep bass (without losing control of your subwoofer speaker cones). Another very important, yet often overlooked technique is to use the EQ to subtract from the mix. Cutting the HIGH control can reduce unwanted hiss during multi-track recording, while attenuating the MID or LOW can eliminate feedback in a live performance or clear up a muddy sounding mix. Cutting away the top and bottom, then pushing up the Gain is equivalent to mid range boost!

[Note: Always reset a channel's input Gain (or external devices' output level) after altering the amount of mixer equalization cut or boost applied.]

The key to successful equalization is to avoid excess. Too much equalization on the input channels will result in a mix that is smeared together with nothing specifically defined. During rehearsals, experiment with the equalizer controls on various instruments, vocals and combinations of these mixed together to become familiar with various equalizer settings.

(6) AUX SEND 1, 2 CONTROLS

Both Aux Sends are mono and post-EQ and control the level of the signals sent to the AUX buses.

- Aux Send 1 is pre-fader and the signal sent to the AUX 1 bus will be unaffected by the channel fader setting.
- Aux Send 2 is post-fader and the signal level sent to the AUX 2 bus will be affected by the channel fader setting.

For almost all effects send purposes, you will want to use the post-fader AUX 2, so that when a fader level is adjusted, any reverb send from that channel follows the fader. Otherwise, when the fader is pulled down, the reverb from that channel would still be audible. Most reverbs etc. internally sum the left and right inputs so that you can use AUX 2. You can also use this AUX 2 send to feed inputs to a multi-track recorder or any other unbalanced line level application.

On the other hand, for cueing purposes and monitor amplifiers, use the pre-fader AUX 1 (i.e. independent of the channel fader)

(7) PAN CONTROL

The Channel Pan positions the output of the channel in the stereo field of the Master Mix. Its constant-power design ensures there are no level discrepancies whether a signal is hard-panned, center-stage, or somewhere in-between.

(8) PEAK LED INDICATOR

The Peak LED illuminates when a channel is going into overload. It detects the peak level after the EQ and will light at 3dB before clipping to warn that the signal is approaching overload. You do not want the Peak LED to light except very intermittently during a take or a mix. If it does light persistently, reduce input gain with the **TRIM control (4)**.

(9) PFL SELECT SWITCH

The PFL (pre-fader listen) switch enables monitoring the mono signal of any channel(s) selected (button depressed) at nominal levels though the headphone or control room monitor outputs [In order to monitor the PFL channels selected, you must also set the Master/PFL to **Control Room switch (20)** to the button depressed (PFL) position].

The signal is post EQ and independent of channel fader position. Selecting the PFL never interrupts the main stereo out or the AUX sends.

(10) CHANNEL FADER

The channel faders determine the output signal level to the Master Mix bus. They offer a smooth logarithmic taper more often associated with much more expensive consoles for optimum control of the signal.

CONTROLS AND CONNECTIONS

2. STEREO INPUT SECTION

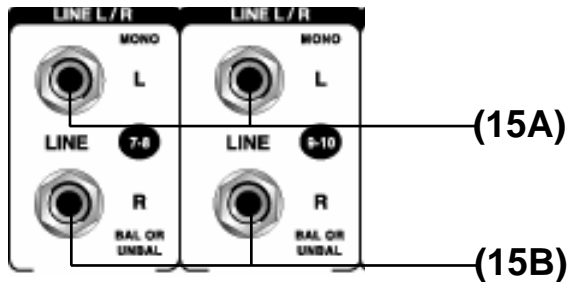

(15A) L (MONO) LINE INPUT

On stereo input channels 5-12 (SRM-12X) or 7-14 (SRM-14X), the 1/4" line inputs are designed for stereo or mono line-level signals such as those from keyboards, drum machines, CD players, tape decks, or samplers. However, these inputs can also be used as standard mono line inputs by connecting the signal to the L (MONO) line in. This signal will be routed equally to the BAL control and the left and right outputs in the same way as the standard line input channels. For the stereo line inputs the mono channel **PAN (7)** control is replaced by the BAL (Balance) control. See also **BAL CONTROL (16)** below.

(15B) R LINE INPUT

When using channels 5-6, 7-8, 9-10,11-12 (SRM-12X) or 7-8, 9-10,11-12, 13-14 (SRM-14X) as stereo input channels, the left signal should be connected to the L input and the right signal to the R input. These signals will be routed to the AUX, EQ and Channel fader controls equally and will retain their stereo separation. The AUX, EQ, BAL, and Channel fader controls all function the same as those on the mono input channels.

When a stereo signal is input to a stereo input channel, these controls will affect the left and right signals equally. The Stereo Line Inputs jacks are 1/4" TRS balanced phone jacks, Tip = positive (+), Ring = negative (-), Sleeve = ground. The input signals to these jacks can be either balanced or unbalanced.

(5) EQUALIZERS

The stereo channel EQ's operate in the same manner as those in the mono channels. The left and right signals will be affected equally. A stereo equalizer is generally preferable anyhow to using two mono equalizers when equalizing a stereo signal as it avoids possible discrepancies between the left and right settings.

(6) AUX SENDS

These are the same as for the mono channels. Note that a mono sum is taken from the stereo input.

(16) BAL CONTROL

For a mono input to the L (MONO) input the function of the control is the same as the **PAN controls (7)** of the mono channels. However, when a channel is run in stereo, this control functions as a Balance control, determining the relative Balance of the left and right channel signals being sent to the left and right Master Mix buses. For example, with the Balance control turned fully clockwise, only the right portion of the channel's stereo signal will be routed to the Master Mix.

(9) PFL SELECT SWITCH (10) CHANNEL FADER

This has the same function as for the mono channels. See **MONO INPUT SECTION**.

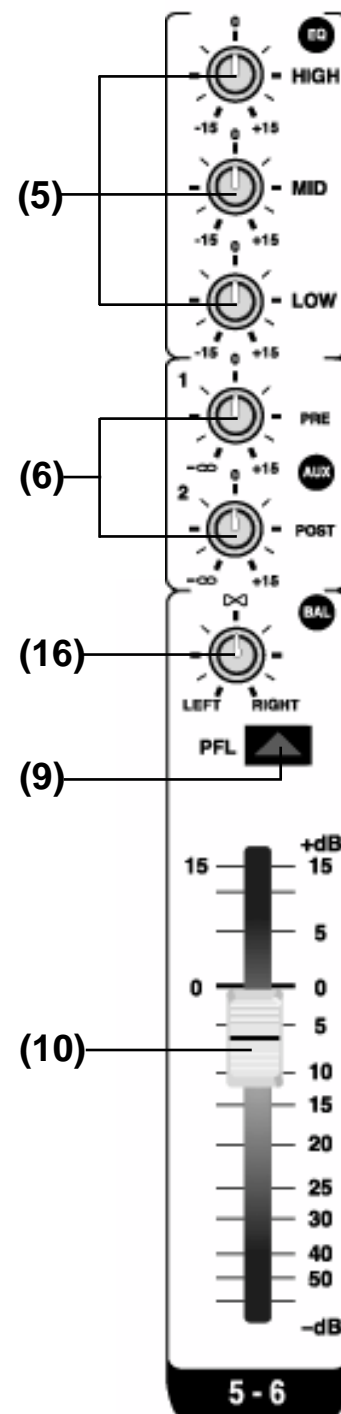

CONTROLS AND CONNECTIONS

3. MASTER SECTION

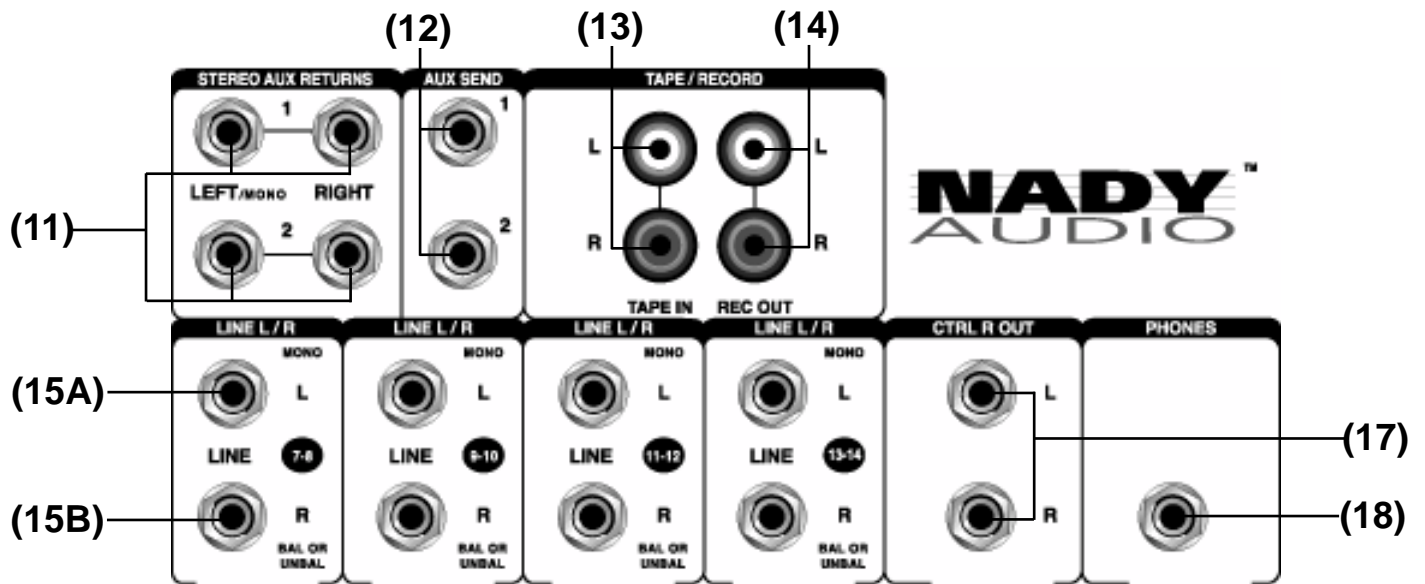

a. AUX Sends>Returns Function and Operation

- (11) STEREO AUX RETURNS (LEFT/MONO, RIGHT)
- (19) AUX 1,2 RETURN CONTROLS

The AUX Return jacks are the mono or stereo returns for AUX 1 and 2. If you connect a signal to the Left/Mono Return jack only, the AUX Return will operate in mono and the signal will be routed to the respective **Aux Return Control (19)** and then mixed into the left and right **Master Mix Stereo Outputs (30)**. The separate left and right return jacks are provided for use with stereo signals such as those from the output of a stereo effects processor. The left and right return signals will be routed to the **Return level controls (19)** and mixed into the left and right **Stereo (30)**, while maintaining stereo separation.

The Aux Returns are multi-functional. They may be used for returning the outputs of effect units, as Tape Returns from a multi-track recorder, or as extra instrument inputs, especially if your MIDI keyboard or rack supplies a pre-mixed stereo signal. Certain stereo effects produce a perceived imbalance between the left and right channel levels. To correct for this you will have to bring your stereo effect back on a stereo channel, which has a **Balance control (16)**. When applying short left and right delays, the shortest one will always seem loudest. When pitch shifting up and down in wide stereo to thicken a sound, the signal shifted upwards will seem louder than one that goes down. In both cases use the Balance control to compensate. When performing any stereo imaging exercise, don't just rely on the control room monitors. Get a pair of headphones and listen in stereo and in reverse stereo, just in case you have any significant hearing discrepancies. Sometimes you might want to narrow the stereo width of a reverb field. To do this you will have to come back on two mono channels to get independent pan for the left and right signals.

(12) AUX SENDS

The Aux Send 1 and 2 jacks are the outputs for the signals sent from the channel **Aux controls (6)**. The Aux Sends and Aux Returns are all 1/4" unbalanced phone jacks wired: Tip = positive (+), Sleeve = ground. AUX 1 is pre-fader and AUX 2 is post-fader. These signals can be sent to the input of an effects processor, multi-track recorder, or used for any other line-level auxiliary purpose. Master Aux Send levels are adjusted by the **Aux Send controls (19)**.

b. Main Mix Function and Operation

- (30) STEREO OUTPUTS
- (13) TAPE INPUTS
- (14) REC OUTPUTS
- (28) MASTER MIX FADER
- (27) LED OUTPUT METER
- (21) TAPE/REC TO MASTER SWITCH

The Stereo Outputs consist of both Left (L) and Right (R) balanced XLR's, wired: pin 1 = ground, pin 2 = hot (+), pin 3 = cold (-), and unbalanced 1/4" phone jacks, wired: Tip = positive (+), Sleeve = ground.

The **REC Outputs (14)** also provide an output of the Master Mix. These outputs are RCA jacks, and designed primarily for inputs to tape recorders, etc. The output level routed to the Stereo Outputs and REC Outputs is determined ultimately by the setting of the **Master Mix fader (28)**. The Master Mix (signal on the master bus) is the sum of the signals routed from all the channels and also the inputs from the AUX return bus and the **TAPE Input (13)**. Use the Tape/Rec to **Master switch (21)** to route signals from the **Tape Input (13)** to the **Master Mix Fader (28)**. The level of signal routed to the **Master Mix fader (28)** from DAT, tape decks, CD players,

CONTROLS AND CONNECTIONS

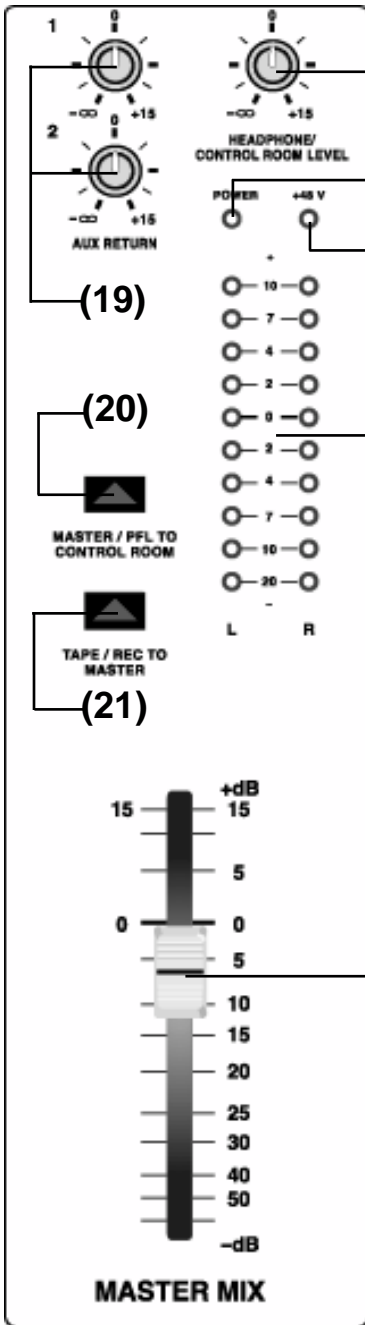

(22) etc., input to the **Tape Input (13)** is determined by the setting of the output volume control of the audio device being connected, so care must be taken in adjusting this level so as to achieve proper balance in the final mix and to prevent overload distortion. The 10-stage **LED Output Meter (27)** displays the Master Mix output level.

c. Monitor Function and Operation

(17) **CONTROL ROOM OUTPUTS**
 (18) **HEADPHONES OUTPUT**
 (22) **PHONES/CONTROL ROOM CONTROL**
 (20) **MASTER/PFL TO CONTROL ROOM SWITCH**
 The SRM-12X/14X allows you to monitor either the Master Mix or any channel(s) selected by the channel PFL Select switch (9). To monitor the Master Mix, the

Master/PFL to Control Room switch (20) must be in the up (unpressed) position. Press the switch down to enable PFL function. In this mode you can now monitor any channel(s) by pressing the channel **PFL Select switch (9)**. In either case, the signal level is adjusted with the **Phones/Control Room control (22)** and routed to both the **Control Room (17)** and **Headphones (18)** outputs. The **L-R Control Room Outputs (17)** can be connected to an amp to power stereo control room (or other) monitor speakers and are 1/4" unbalanced phone jacks, wired: Tip = positive (+), Sleeve = ground.

The **Phones Output** will feed headphones and is a 1/4" TRS jack, wired: tip = left signal, ring = right signal, sleeve = ground.

d. Power Switches

(31) **AC POWER IN SOCKET**

(23) **MAIN POWER SWITCH**

(24) **POWER ON LED INDICATOR**

Once the external PSU is connected to the **AC Power In socket (31)** and then to the AC power source, you may switch on your mixers with the **Power On switch (23)**. The **Power "ON" LED (24)** will light up. Allow 1 minute after powering up for the system to reach equilibrium before setting inputs gains and other levels.

(25) **PHANTOM POWER SWITCH**

(26) **PHANTOM POWER ON LED INDICATOR**

When using condenser mics, +48VDC can be switched globally on or off to the XLR mic inputs for all mono channels (also see **MONO INPUT SECTION, MIC INPUTS**). When this switch is in the "ON" position, The **Phantom Power On LED Indicator (26)** will light, and +48VDC will be provided between pins 2 and 3 on all the mono Mic input XLR connectors. If you don't need phantom power, be sure to turn this switch to the "OFF" position.

[Note: It is safe to connect balanced dynamic mics or line level devices even if this switch is on, but connecting unbalanced devices or devices whose transformers are center-grounded will cause hum or malfunctions. Shorting the +48VDC can also damage your mixer. Also, mute the Monitor/PA speakers when turning the phantom power on or off.]

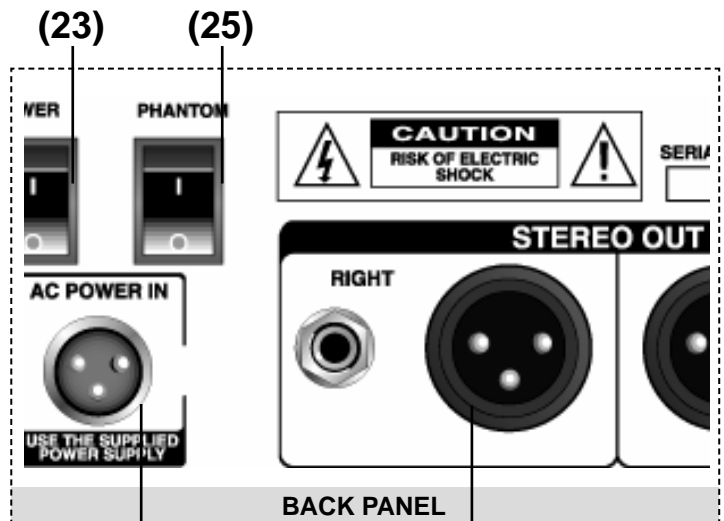

(31)

(30)

CONNECTIONS

This NADY AUDIO console uses 4 different types of audio connectors for the various input/output connections: (1) XLR balanced; (2) 1/4" TRS phone jacks for balanced, unbalanced, stereo, or in/out inserts; (3) 1/4" TRS unbalanced; (4) RCA pin unbalanced

Figures

1. *Balanced XLR input/output connections*
2. *Stereo headphone connection with 1/4" TRS plug*
3. *1/4" mono (TRS) plug used as unbalanced input/output*
4. *1/4" stereo (TRS) plug used as balanced input/output*
5. *1/4" TRS plug used as Insert Send/Return*
6. *RCA pin plug for unbalanced input/output*

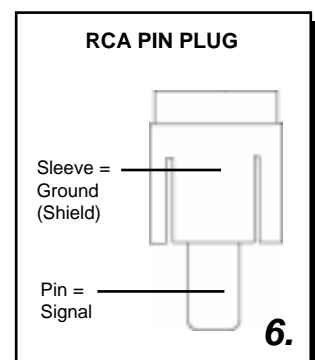
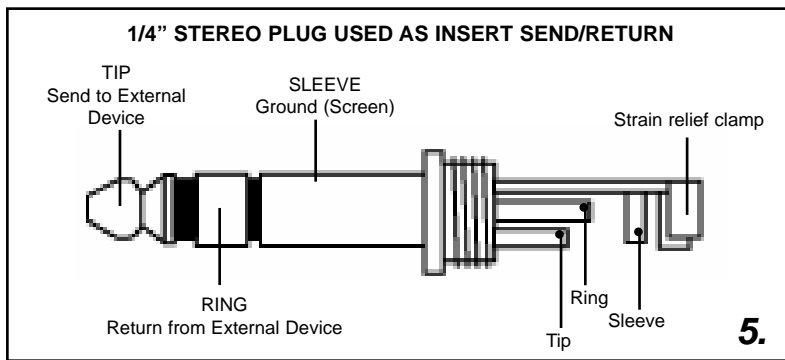
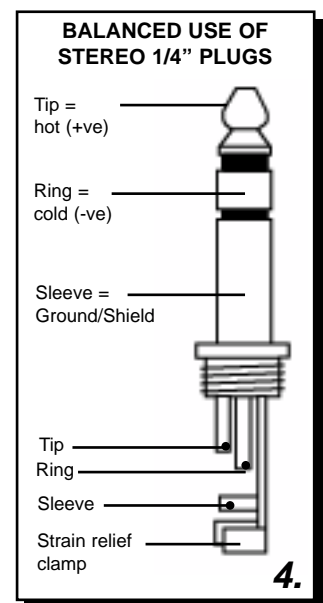
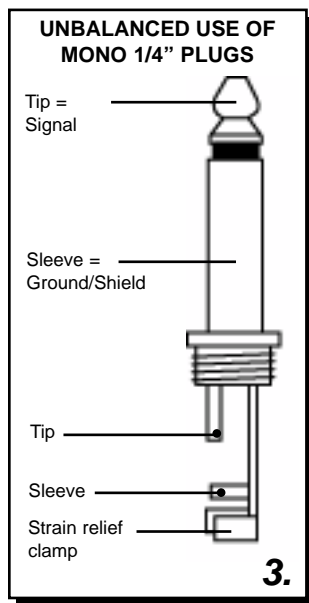
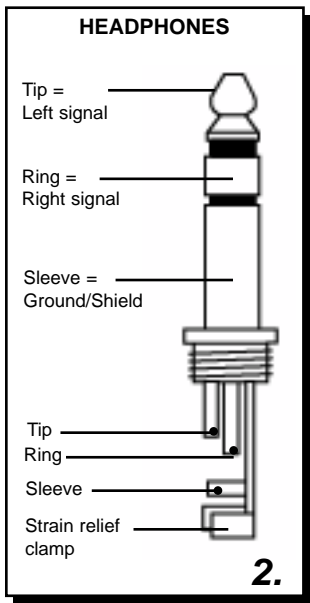
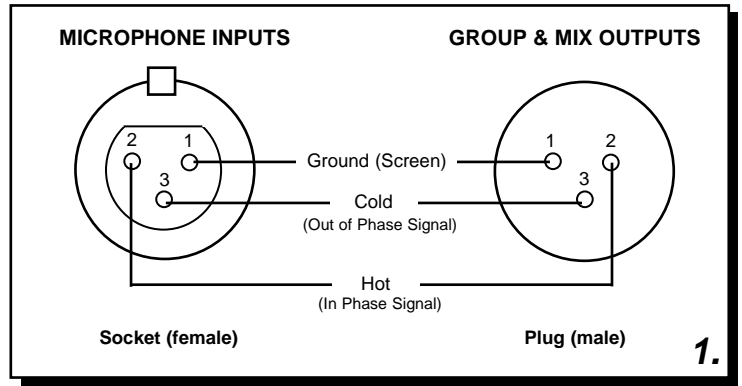

SPECIFICATIONS

1. INPUT SECTION

Input	Connector	Input Impedance	Nominal Level	Max Level
MONO CH MIC	XLR	>1.3K Ω	+2 dBm	+14 dBm
MONO CH LINE	1/4" TRS	>10K Ω	+4 dBm	+22 dBm
STEREO CH LINE	1/4" TRS	>10K Ω	+4 dBm	+22 dBm
TAPE IN	RCA PIN JACKS	>10K Ω	+2 dBm	+22 dBm
AUX RETURNS	1/4" TS	>10K Ω	+4 dBm	+22 dBm
INSERT IN	1/4" TRS	>10K Ω	+4 dBm	+22 dBm

2. OUTPUT SECTION

Output	Connector	Output Impedance	Nominal Level	Max Level
STEREO OUT L/R	XLR & 1/4" TS	120 Ω	+4~+6 dBm	+22 dBm
AUX SENDS 1,2	1/4" TS	120 Ω	+4~+6 dBm	+20 dBm
INSERT OUT	1/4" TRS	120 Ω	+4~+6 dBm	+22 dBm
CNTRL R. OUT	1/4" TS	1K Ω	+4~+6 dBm	+22 dBm
REC OUT	RCA PIN JACKS	1K Ω	+4~+6 dBm	+22 dBm
PHONES	1/4" TRS	200 Ω	—	40mW X 2

3. FREQUENCY RESPONSE

ANY INPUT TO
 ANY OUTPUT20 Hz to 20 KHz \pm 3dB @ 0 dBm

4. TOTAL HARMONIC DISTORTION

ANY INPUT TO
 ANY OUTPUT0.02%, 20 Hz-20 KHz @ 1KHz, 0 dBm

5. INPUT CHANNEL EQUALIZATION

High shelving12 kHz, \pm 15 dB, Q fixed at 2 oct.
 Mid bell2.5 kHz, \pm 15 dB, Q fixed at 1 oct.
 Low shelving80 Hz, \pm 15 dB, Q fixed at 2 oct.
 Low Cut (High Pass)
 filter (Mono channels only).....75 Hz, -3 dB (18 dB/octave)

6. GAIN CONTROL RANGE

Mono input channel
 trim control.....Stop to stop- Mic +10 dB~+60 dB
 Channel/Master Faders $-\infty$ to +15 dB
 Aux SendOff to +15 dB
 Aux ReturnOff to Unity to +15 dB

7. CROSSTALK @ 1KHZ

ADJACENT CHANNEL INPUTS-78 dB~-68 dB
 INPUT TO OUTPUT -78 dB~-68 dB

8. HUM AND NOISE

20 Hz-20 KHz, R_s =150 ohms, input TRIM @ 0 dB, input sensitivity at -60 dB
 EQUIVALENT INPUT NOISE-129 dBm
 RESIDUAL OUTPUT NOISE.....-85 dBm

9. VU METERS

10-segment LED X 2

10. PHANTOM POWER

+48 VDC, globally selected

11. POWER REQUIREMENTS

External PSU, 120 VAC/60Hz or 230 VAC/50Hz

12. POWER CONSUMPTION

25 Watts, External PSU

13. DIMENSIONS AND WEIGHT

SRM-12X: 13.5" x 11.5" x 3" (343 x 292 x 76 mm),
 7.9 lbs (3.7 Kg)
SRM-14X: 13.5" x 13.5" x 3" (343 x 343 x 76 mm),
 9.3 lbs (4.2 Kg)
 External PSU not included

The specifications above are correct at the time of printing of this manual. For improvement purposes, all specifications for this unit, including design and appearance, are subject to change without prior notice.

BLOCK DIAGRAM

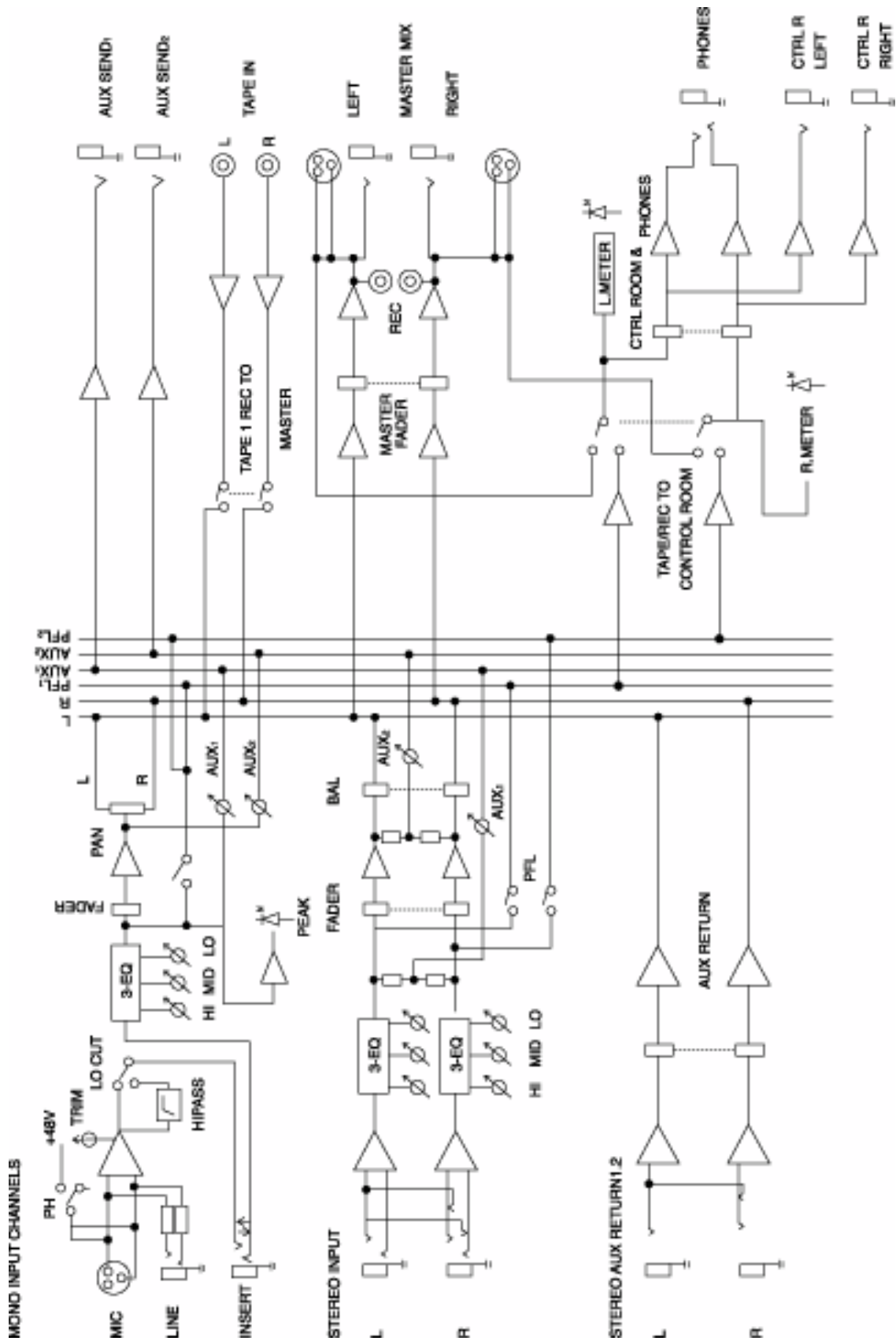

NOTES

SERVICE FOR YOUR NADY AUDIO PRODUCT

(U.S.) Should your NADY AUDIO product require service, please contact the Nady Service Department via telephone at (510) 652-2411, or e-mail at service@nadywireless.com.

(International) For service, please contact the NADY AUDIO distributor in your country through the dealer from whom you purchased this product.

DO NOT ATTEMPT TO SERVICE THIS UNIT
YOURSELF AS IT CAN BE DANGEROUS
AND WILL ALSO VOID THE WARRANTY.

